

一層平面圖

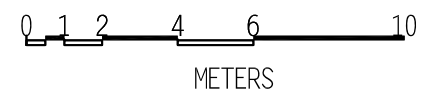

二層平面圖

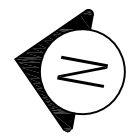

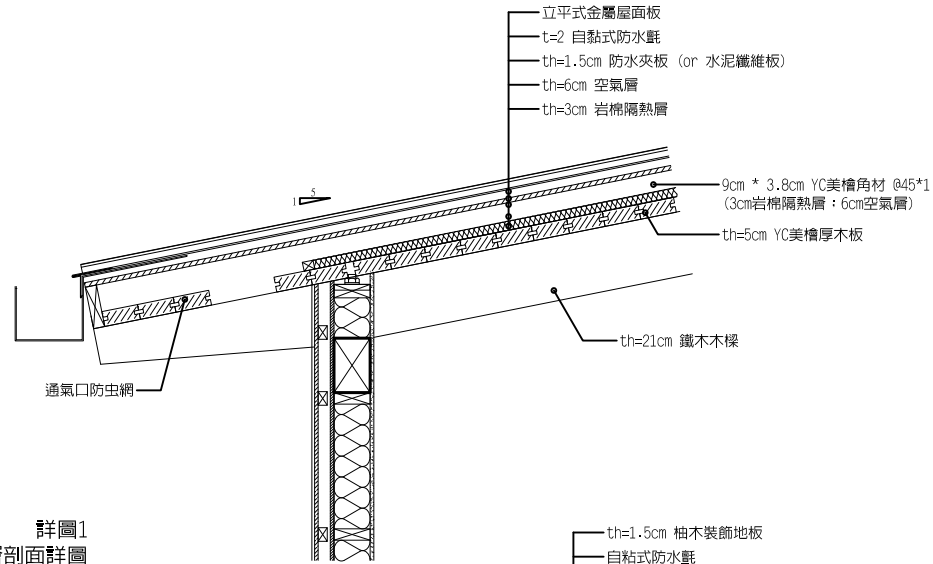

詳圖1
屋頂層剖面詳圖

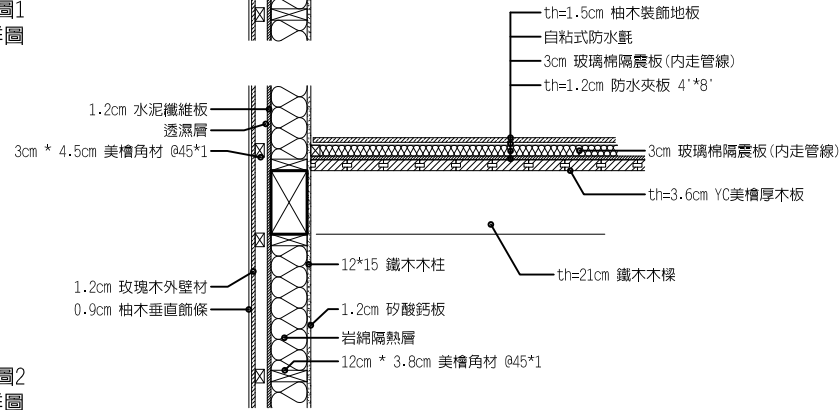

詳圖2
二樓樓板剖面詳圖

屋頂、樓板、牆剖面詳圖

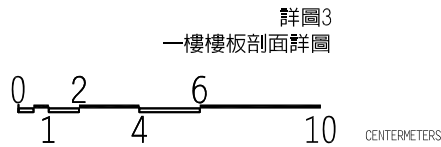

詳圖3
一樓樓板剖面詳圖

CENTERMETERS

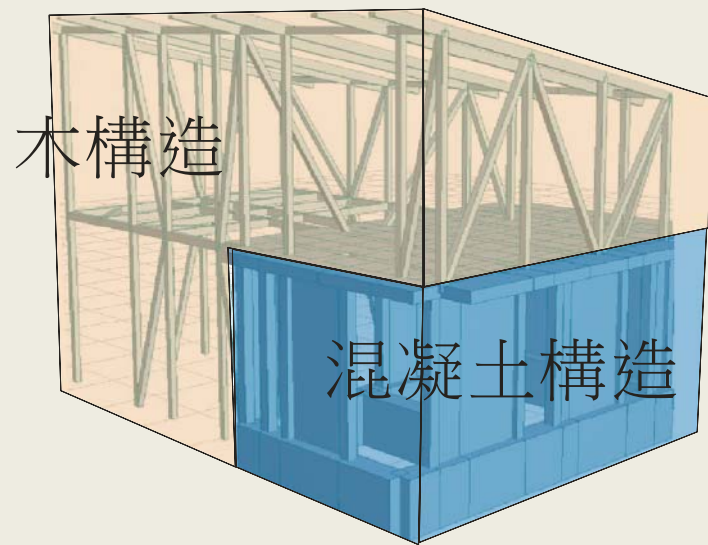

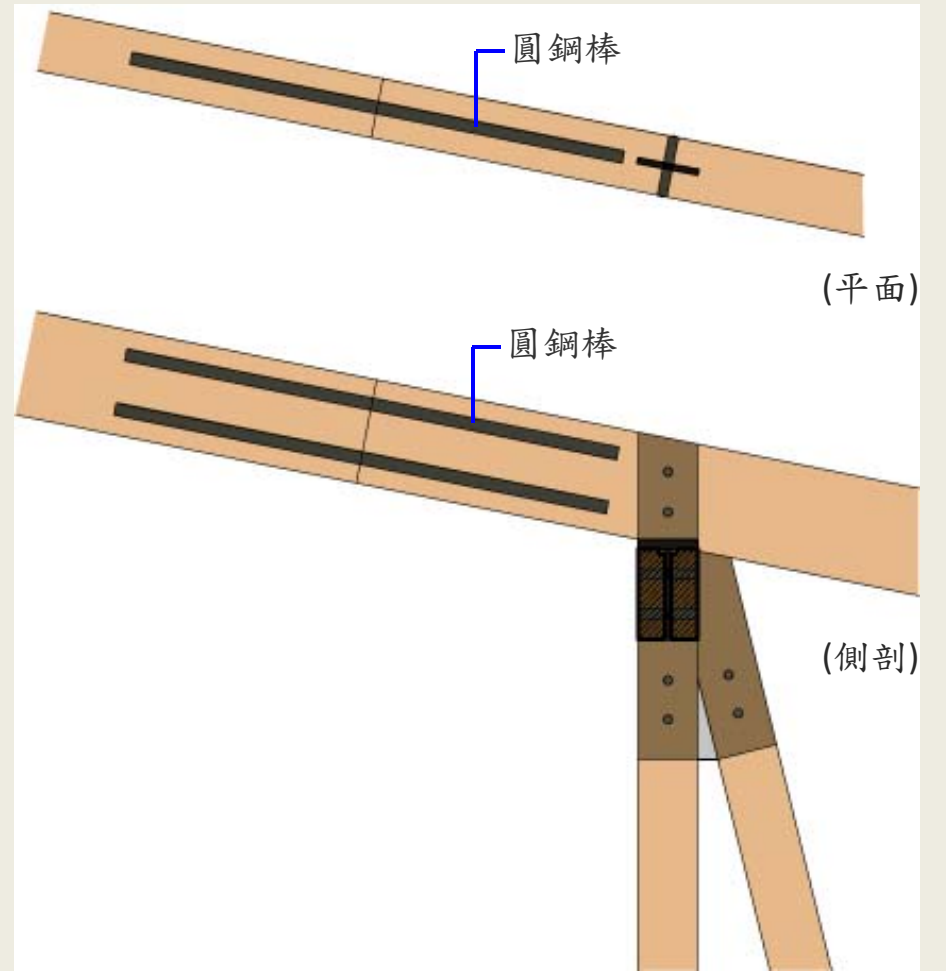
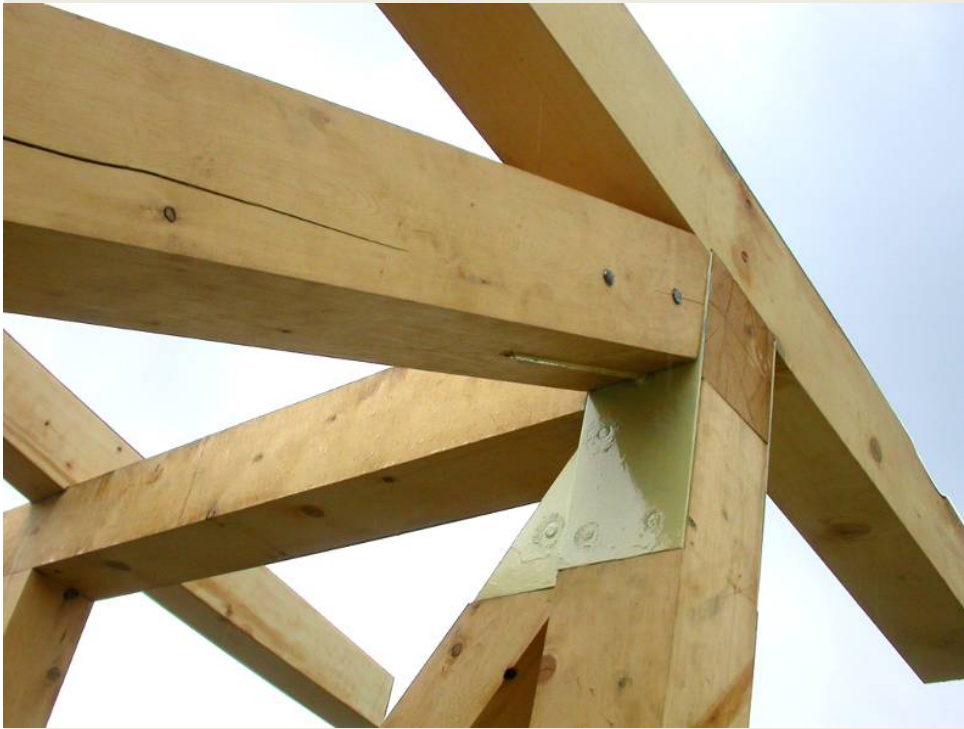

植筋工法

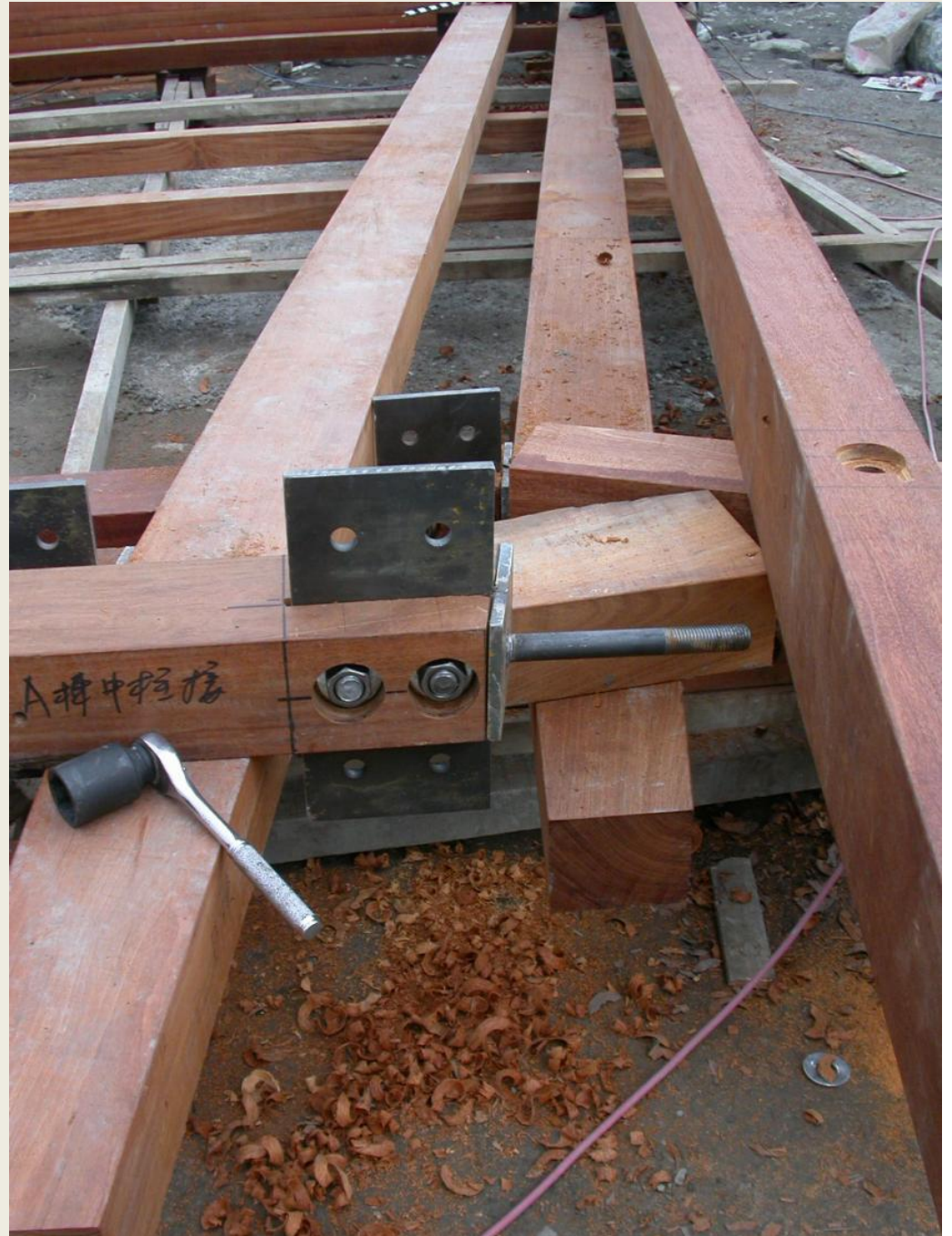

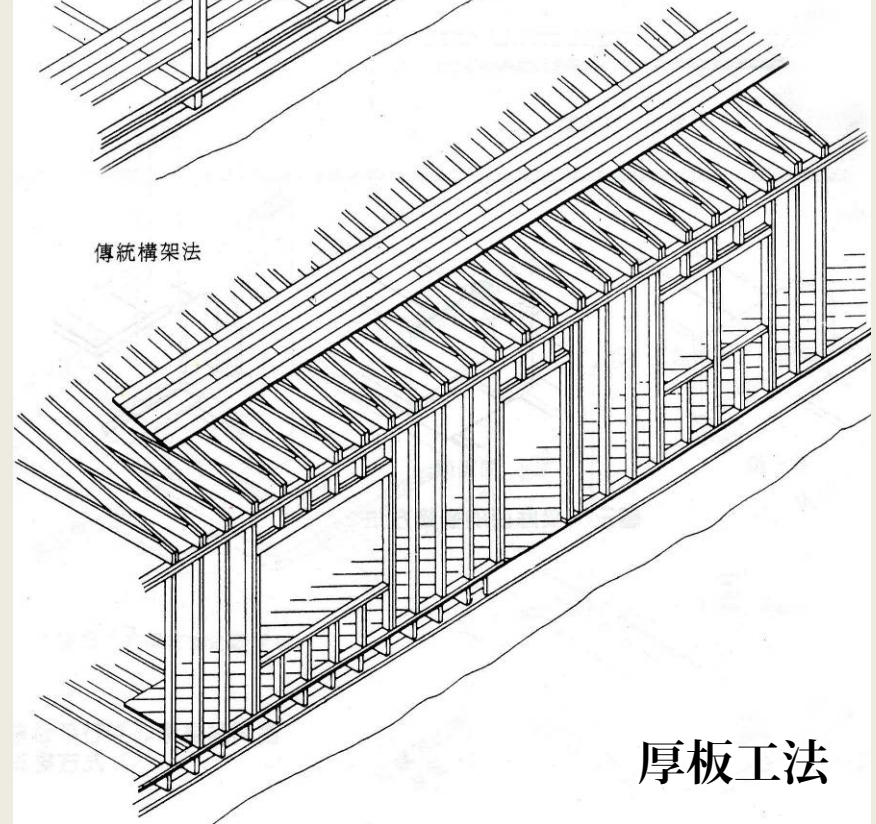
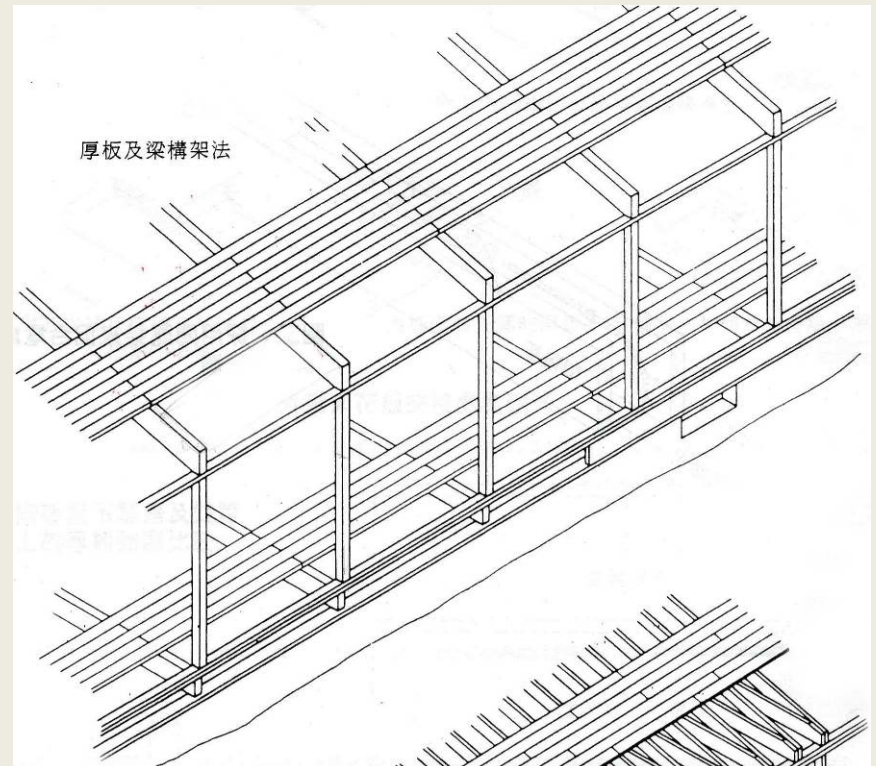

厚板工法

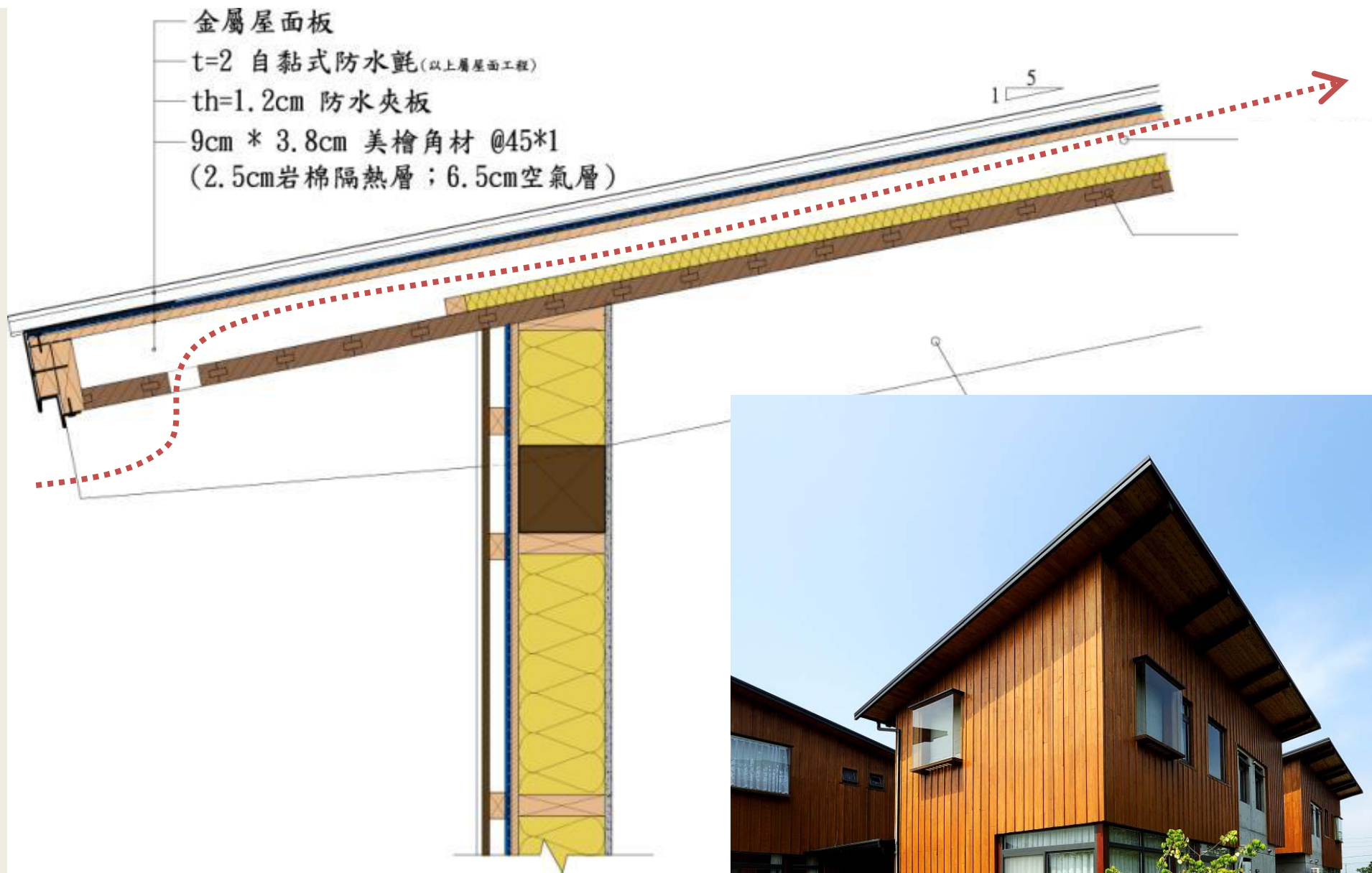

天花詳圖